

The battery is manufactured with PVC-SiO₂ separator and colloidal or fumed silica. The tubular positive plate and pasted negative palte is applied. The batteries use silica gel to immobilize the electrolyte inside the battery. The proven silica gel technology improves battery cycle life and performance at various ambient temperatures.

Battery Construction

Component	Positive plate	Negative plate	Container	Cover	Safety valve	Terminal	Separator	Electrolyte
Raw material	Tubular	Lead	ABS	ABS	Rubber	Copper	PVC-SiO ₂	Fumed silicon

General Feature

- The battery has a long service life, under float charging, ambient temperature 25°C, it can operate 15-20 years.
- Excellent Recovery from deep discharge and good deep discharge cycle capability.
- the battery has a low self-discharge, keep over 60% of the rated capacity after 2 years stored under 25°C
- High Reliability and Quality

SPECIFICATION

Nominal voltage 2V
 Number of cell 1
 Length(mm/inch) 210/8.26
 Width(mm/inch) 191/7.52
 Height(mm/inch) 645/25.4
 Total Height(mm/inch) 671/26.4
 Approx. Weight (kg/lbs) 58/127.8

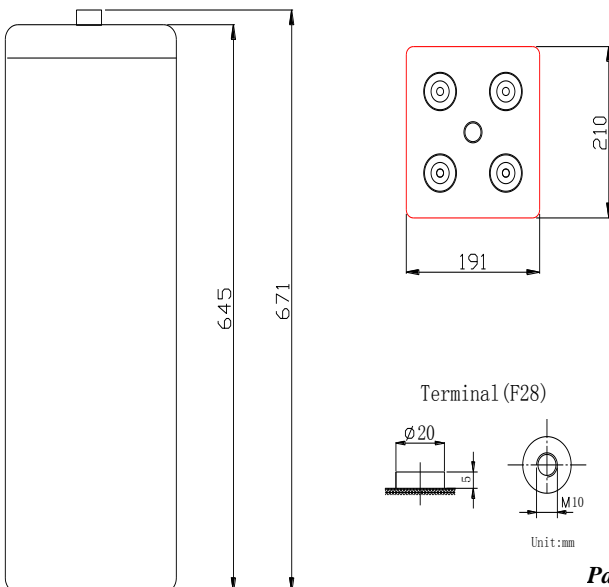

Performance Characteristics

Capacity 77°F(25°C)	240 hour rate (4.26A、1.85V)	1055Ah
	48 hour rate (20A、1.85V)	1000Ah
	10 hour rate (80A、1.8V)	800Ah
	3 hour rate (200A、1.8V)	600Ah
Internal Resistance	Full charged Battery 77°F(25°C): 0.32mΩ	
Operating Temperature Range	Discharge: -20~65°C	
	Charge: -10~65°C	
	Storage: -20~65°C	
Self-Discharge 1.5% of capacity declined per month at 20°C (average)		
Max. discharge current 77°F(25°C): 4000A(5S)		
Charge (Constant Voltage)	Float: 2.23~2.27 V/77°F(25°C)	
	Cycle: 2.38~2.42 V/77°F(25°C) Max. Current: 120A	

Discharge Constant Current (Amperes at 77° F/25°C)

End Point Volts/Cell	15min	30min	1h	3h	5h	10h	24h	48h	120h
1.65V	970	724	454	219	143	---	---	---	---
1.70V	905	689	435	213	139	---	---	---	---
1.75V	835	652	415	207	135	82.0	---	---	---
1.80V	762	613	393	200	131	80.0	---	---	---
1.85V	682	568	367	191	125	77.0	35.8	20.0	8.5

Discharge Constant Power (watts at 77° F/25°C)

End Point Volts/Cell	15min	30min	1h	3h	5h	10h	24h	48h	120h
1.65V	1892	1411	904	411	290	---	---	---	---
1.70V	1772	1331	869	399	283	---	---	---	---
1.75V	1647	1246	831	373	275	156	---	---	---
1.80V	1517	1158	791	359	266	153	---	---	---
1.85V	1377	1058	746	342	255	145	71.3	39.8	16.9

(Note) The above characteristics data are average values obtained within three charge/discharge cycles not the minimum values.

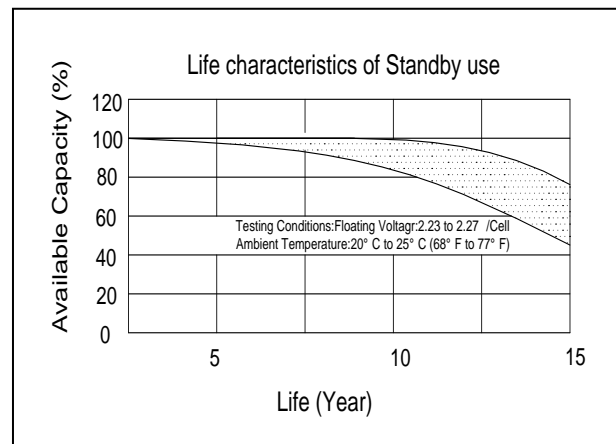
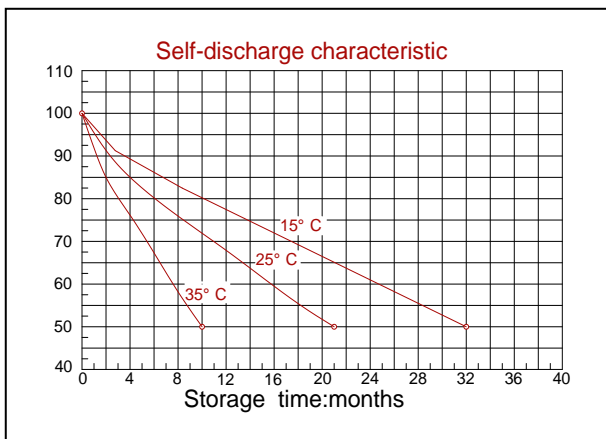
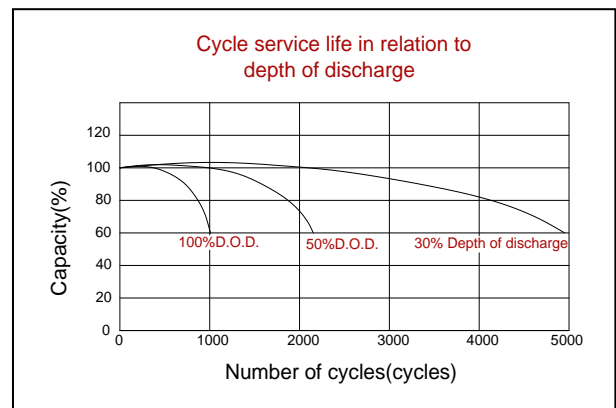
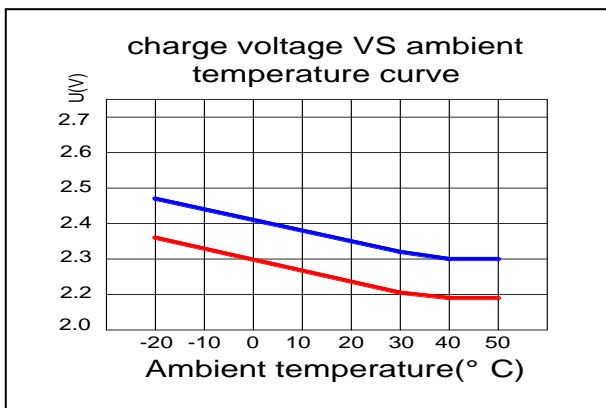
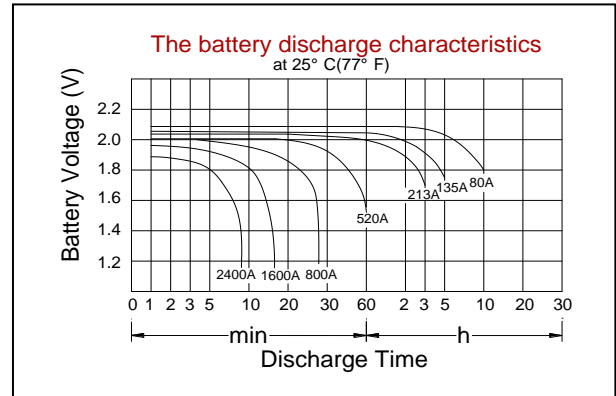
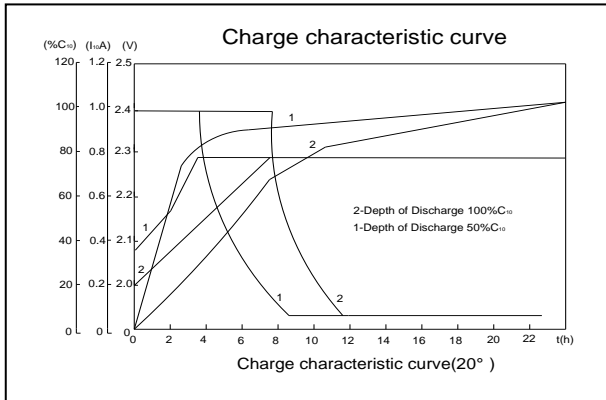

DONGGUAN OREMA POWER CO., LTD

Add: #1 Qilinling Road Shahu, Tangxia Town, Dongguan Guangdong China

TEL: +86-769- 3896 1163 +86-769- 3896 1168

FAX: +86-769- 3896 1169



www.oremabattery.com