

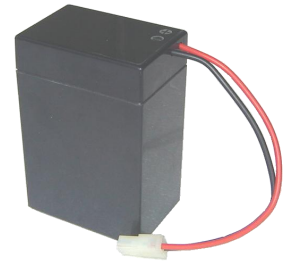

# UN4.5-6T (6V4.5Ah/20hr)

The rechargeable batteries are lead-lead dioxide systems. The dilute sulfuric acid electrolyte is absorbed by separators and thus immobilized.



Should the battery be accidentally overcharged producing hydrogen and oxygen, Special one-way valves allow the gases to escape thus avoiding excessive pressure build-up. Otherwise, the battery is completely sealed and is, therefore, maintenance-free, leak proof and usable in any position.

## Battery Construction

Component	Positive plate	Negative plate	Container	Cover	Safety valve	Terminal	Separator	Electrolyte
Raw material	Lead dioxide	Lead	ABS	ABS	Rubber	Copper	Fiberglass	Sulfuric acid

## General Feature

- Absorbent Glass Mat(AGM) technology for efficient gas recombination of up to 99% and freedom from electrolyte maintenance or water adding.
- Not restricted for air transport-complies with IATA/ICAO Special Provision A67.
- UL-recognized component.
- Can be mounted in any orientation.
- Computer designed lead, calcium tin alloy grid for high power density.
- Long service life, float or cyclic applications.
- Maintenance-free operation.
- Low self discharge.

## Performance Characteristics

Capacity 77°F(25°C)	20 hour rate (0.225A、5.25V)	4.5Ah
	10 hour rate (0.43A、5.25V)	4.3Ah
	5 hour rate (0.78A、5.25V)	3.9Ah
	1 hour rate (2.8A、4.8V)	2.8Ah
Internal Resistance	Full charged Battery77°F(25°C):30mΩ	
Capacity affected by Temperature (20 hour rate)	104° F(40°C)	102%
	77° F(25°C)	100%
	32° F(10°C)	85%
	5° F(-15°C)	65%
Self-Discharge 68°F(20°C)	Capacity after 3 month storage	90%
	Capacity after 6 month storage	80%
	Capacity after 12month storage	60%
Max. discharge current77°F(25°C): 67.5A(5S)		
Charge (Constant Voltage)	Float: 6.80~6.90 V/77° F(25°C)	
	Cycle:7.25~7.45 V/77°F(25°C) Max. Current: 1.13A	

## SPECIFICATION

- Nominal voltage ..... 6V
- Number of cell ..... 3
- Length(mm/inch) ..... 70/2.76
- Width(mm/inch) ..... 47/1.85
- Height(mm/inch) ..... 101/3.98
- Total Height(mm/inch) ..... 101/3.98
- Approx. Weight (kg/lbs) ..... 0.75/1.65

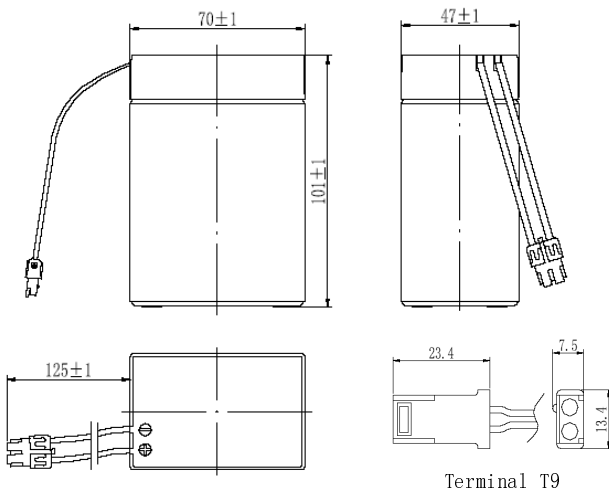

Discharge Constant Current (Amperes at 77° F 25 °C)

End Point Volts/Cell	5min	10min	15min	30min	1h	3h	5h	10h	20h
1.60V	15.8	11.0	8.90	4.80	2.80	1.25	0.87	0.46	0.233
1.65V	15.0	10.5	8.52	4.62	2.70	1.20	0.84	0.45	0.231
1.70V	14.1	10.1	8.10	4.40	2.60	1.15	0.81	0.44	0.228
1.75V	13.3	9.58	7.65	4.23	2.50	1.10	0.78	0.43	0.225
1.80V	12.4	9.00	7.20	3.95	2.40	1.05	0.75	0.42	0.221

Discharge Constant Power (watts at 77° F 25 °C)

End Point Volts/Cell	5min	10min	15min	30min	45min	1h	2h	3h	5h
1.60V	31.7	22.2	17.6	9.50	7.63	5.33	3.40	2.45	1.56
1.65V	29.7	20.9	16.6	9.03	7.28	5.11	3.29	2.39	1.54
1.70V	27.7	19.6	15.7	8.54	6.92	4.87	3.18	2.33	1.51
1.75V	25.8	18.3	14.7	8.04	6.54	4.63	3.06	2.26	1.47
1.80V	23.9	17.1	13.7	7.54	6.16	4.38	2.93	2.18	1.44

(Note)The above characteristics data are average values obtained Within three charge/discharge cycles not the minimum values.

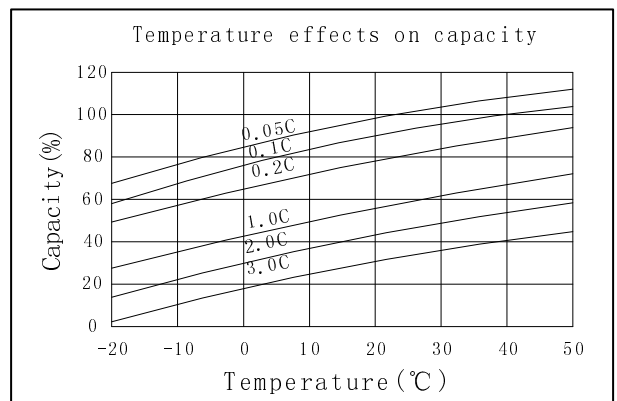
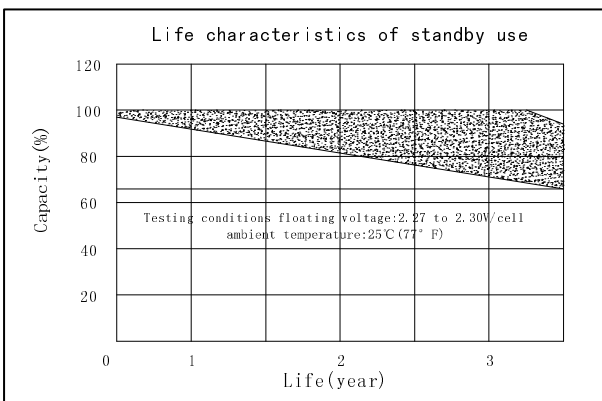
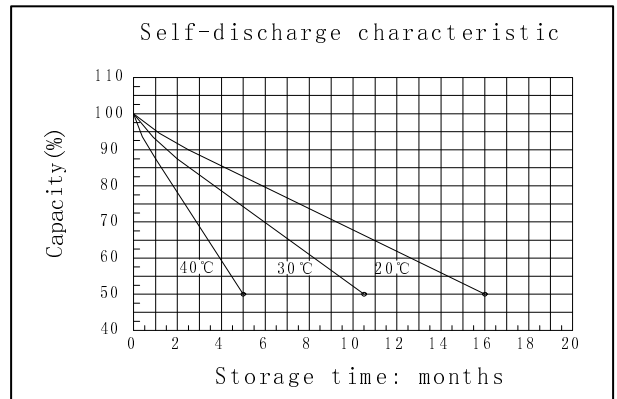
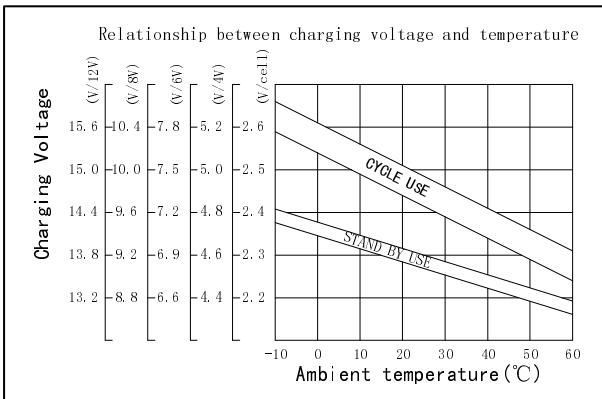
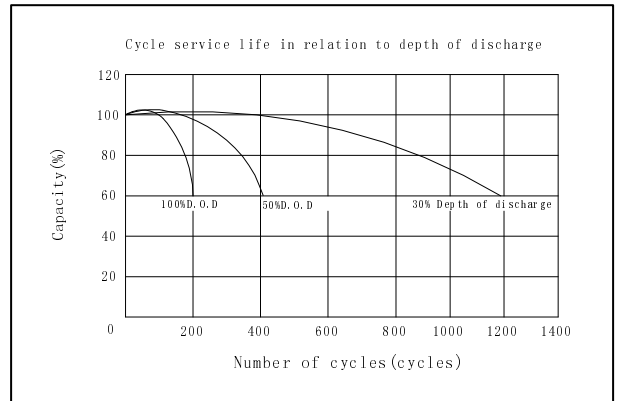
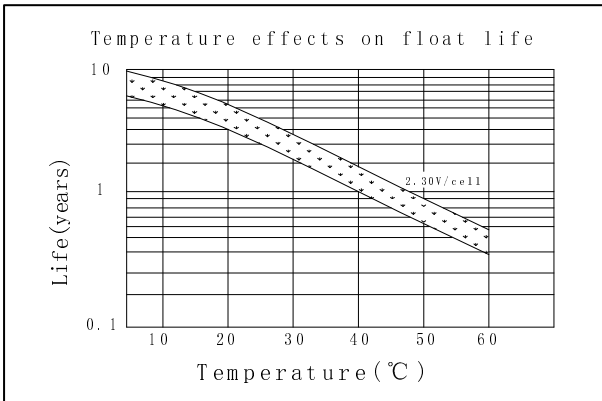
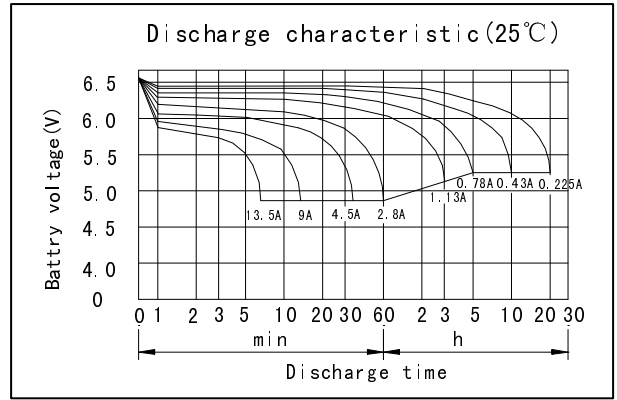
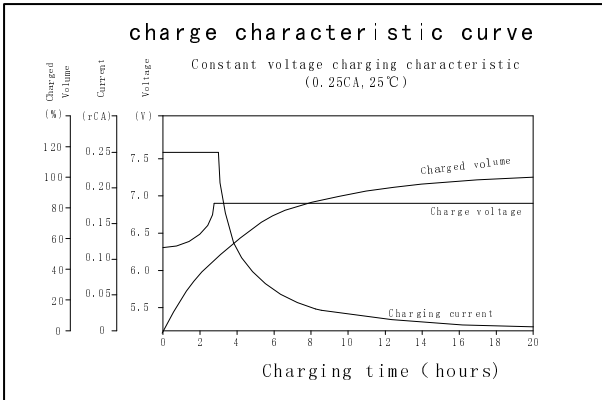

**OREMA POWER CO., LTD**

Add: Datang Industry Park Xinfeng Ganzhou City, Jiangxi Province, China

TEL: +86-0797-2299669 +86-0797- 2299553

FAX: +86-0797-2299553



[www.oremabattery.com](http://www.oremabattery.com)